

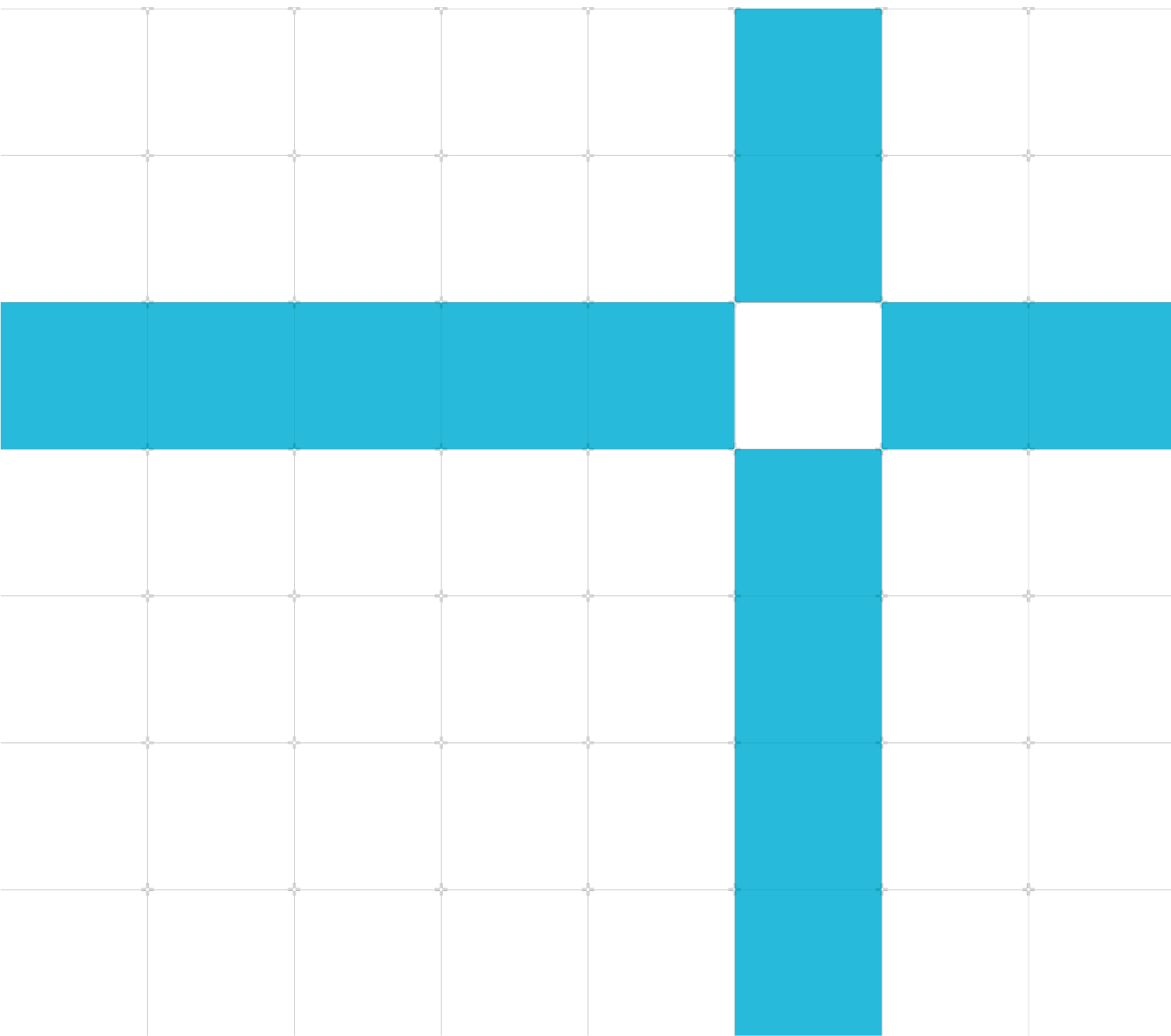

# Armv8-A Instruction Set Architecture

Non-Confidential  
Copyright © 2019-2020 Arm Limited (or its  
affiliates). All rights reserved.

**Issue 1.1**  
**ARM062-948681440-3280**



## Armv8-A Instruction Set Architecture

Copyright © 2019-2020 Arm Limited (or its affiliates). All rights

reserved. Release information

Document history

Issue	Date	Confidentiality	Change
1.0	26 June 2019	Non-Confidential	First release
1.1	03 July 2020	Non-Confidential	Fixes to examples in “Conditional select instructions” and “Procedure Call Standard” sections.

## Non-Confidential Proprietary Notice

This document is protected by copyright and other related rights and the practice or implementation of the information contained in this document may be protected by one or more patents or pending patent applications. No part of this document may be reproduced in any form by any means without the express prior written permission of Arm. No license, express or implied, by estoppel or otherwise to any intellectual property rights is granted by this document unless specifically stated.

Your access to the information in this document is conditional upon your acceptance that you will not use or permit others to use the information for the purposes of determining whether implementations infringe any third party patents.

THIS DOCUMENT IS PROVIDED “AS IS”. ARM PROVIDES NO REPRESENTATIONS AND NO WARRANTIES, EXPRESS, IMPLIED OR STATUTORY, INCLUDING, WITHOUT LIMITATION, THE IMPLIED WARRANTIES OF MERCHANTABILITY, SATISFACTORY QUALITY, NON-INFRINGEMENT OR FITNESS FOR A PARTICULAR PURPOSE WITH RESPECT TO THE DOCUMENT. For the avoidance of doubt, Arm makes no representation with respect to, and has undertaken no analysis to identify or understand the scope and content of, patents, copyrights, trade secrets, or other rights.

This document may include technical inaccuracies or typographical errors.

TO THE EXTENT NOT PROHIBITED BY LAW, IN NO EVENT WILL ARM BE LIABLE FOR ANY DAMAGES, INCLUDING WITHOUT LIMITATION ANY DIRECT, INDIRECT, SPECIAL, INCIDENTAL, PUNITIVE, OR CONSEQUENTIAL DAMAGES, HOWEVER CAUSED AND REGARDLESS OF THE THEORY OF LIABILITY, ARISING OUT OF ANY USE OF THIS DOCUMENT, EVEN IF ARM HAS BEEN ADVISED OF THE POSSIBILITY OF SUCH DAMAGES.

This document consists solely of commercial items. You shall be responsible for ensuring that any use, duplication or disclosure of this document complies fully with any relevant export laws and regulations to assure that this document or any portion thereof is not exported, directly or indirectly, in violation of such export laws. Use of the word “partner” in reference to Arm’s customers is not intended to create or refer to any partnership relationship with any other company. Arm may make changes to this document at any time and without notice.

If any of the provisions contained in these terms conflict with any of the provisions of any click through or signed written agreement covering this document with Arm, then the click through or signed written agreement prevails over and supersedes the conflicting provisions of these terms. This document may be translated into other languages for convenience, and you agree that if there is any conflict between the English version of this document and any translation, the terms of the English version of the Agreement shall prevail.

The Arm corporate logo and words marked with ® or ™ are registered trademarks or trademarks of Arm Limited (or its subsidiaries) in the US and/or elsewhere. All rights reserved. Other brands and names mentioned in this document may be the trademarks of their respective owners. Please follow Arm's trademark usage guidelines at <http://www.arm.com/company/policies/trademarks>.

Copyright © 2017 Arm Limited (or its affiliates). All rights reserved.

Arm Limited. Company 02557590 registered in England.

110 Fulbourn Road, Cambridge, England CB1 9NJ.

LES-PRE-20349

## Confidentiality Status

This document is Non-Confidential. The right to use, copy and disclose this document may be subject to license restrictions in accordance with the terms of the agreement entered into by Arm and the party that Arm delivered this document to.

Unrestricted Access is an Arm internal classification.

## Product Status

The information in this document is Final, that is for a developed product.

## Web Address

[www.arm.com](http://www.arm.com)

# Contents

<b>1 Overview .....</b>	<b>6</b>
<b>2 Why you should care about the ISA.....</b>	<b>7</b>
<b>3 Instruction sets in the Armv8-A.....</b>	<b>8</b>
<b>4 Instruction set resources.....</b>	<b>9</b>
<b>5 Simple sequential execution .....</b>	<b>10</b>
<b>6 Registers in AArch64.....</b>	<b>11</b>
6.1 General-purpose registers .....	11
6.2 Other registers.....	12
6.3 System registers .....	13
<b>7 Data processing .....</b>	<b>14</b>
7.1 Arithmetic and logic operations .....	14
7.2 Floating point.....	15
7.2.1 Is floating point support optional? .....	15
7.3 Bit manipulation.....	16
7.4 Extension and saturation .....	17
7.4.1 Sub-register-sized integer data processing.....	18
7.5 Format conversion.....	19
7.6 Vector data .....	20
<b>8 Loads and stores .....</b>	<b>21</b>
8.1 Size .....	21
8.2 Zero and sign extension.....	22
8.3 Addressing .....	23
8.4 Load pair and store pair .....	25
8.5 Using floating point registers .....	25
<b>9 Program flow .....</b>	<b>26</b>
9.1 Loops and decisions.....	26
9.1.2 Unconditional branch instructions.....	26

9.1.3 Conditional branch instructions .....	26
9.2 Generating condition code .....	28
9.3 Conditional select instructions.....	30
<b>10 Function calls .....</b>	<b>32</b>
<b>11 Procedure Call Standard.....</b>	<b>33</b>
<b>12 System calls .....</b>	<b>35</b>
<b>13 Check your knowledge .....</b>	<b>36</b>
<b>14 Related information .....</b>	<b>37</b>
14.1 Instruction set resources.....	37
14.2 Procedure Call Standard .....	37
14.3 Useful links to training.....	37
<b>15 Next steps .....</b>	<b>38</b>

# 1 Overview

An *Instruction Set Architecture* (ISA) is part of the abstract model of a computer. It defines how software controls the processor.

The Arm ISA allows you to write software and firmware that conforms to the Arm specifications. This means that, if your software or firmware conforms to the specifications, any Arm-based processor will execute it in the same way.

This guide introduces the A64 instruction set, used in the 64-bit Armv8-A architecture, also known as AArch64.

We will not cover every single instruction in this guide. All instructions are detailed in the *Arm Architecture Reference Manual* (Arm ARM). Instead, we will introduce the format of the instructions, the different types of instruction, and how code written in assembler can interact with compiler-generated code.

At the end of this guide, you can [check your knowledge](#). You will have learned about the main classes of instructions, the syntax of data-processing instructions, and how the use of W and X registers affects instructions. The key outcome that we hope you will learn from this guide is to be able to explain how generated assembler code maps to C statements, when given a C program and the compiler output for it. Finally, this guide will show you how to write a function in assembler that can be called from C.

# 2 Why you should care about the ISA

As developers, you may not need to write directly in assembler in our day-to-day role. However, assembler is still important in some areas, such as the first stage boot software or some low-level kernel activities.

Even if you are not writing assembly code directly, understanding what the instruction set can do, and how the compiler makes use of those instructions, can help you to write more efficient code. It can also help you to understand the output of the compiler. This can be useful when debugging.



# 3 Instruction sets in the Armv8-A

Armv8-A supports three instruction sets: A32, T32 and A64.

The A64 instruction set is used when executing in the AArch64 Execution state. It is a fixed-length 32-bit instruction set. The '64' in the name refers to the use of this instruction by the AArch64 Execution state. It does not refer to the size of the instructions in memory.

The A32 and T32 instruction sets are also referred to as 'ARM' and 'Thumb', respectively. These instruction sets are used when executing in the AArch32 Execution state. In this guide, we do not cover the A32 and T32 instruction sets. To find out more about these instruction sets, see the Related Information section of this guide.

# 4 Instruction set resources

Each version of the Arm architecture has its own Arm Architecture Reference Manual (Arm ARM), which can be found on the [Arm Developer website](#). Every Arm ARM provides a detailed description of each instruction, including:

- Encoding - the representation of the instruction in memory.
- Arguments - inputs to the instruction.
- Pseudocode - what the instruction does, as expressed in Arm pseudocode language.
- Restrictions - when the instruction cannot be used, or the exceptions it can trigger.

The instruction descriptions for A64 are also available in XML and HTML. The XML and HTML formats are useful if you need to refer to the instructions often. The XML and HTML formats can be found on the Arm Developer website. You can find a link in the Related information section of this guide. The XML can be downloaded as a compressed archive and the HTML can be viewed and searched using a web browser.

**Note: The information in the XML/HTML and the Arm ARM are taken from the same source but may be formatted slightly differently.**

# 5 Simple sequential execution

The Arm architecture describes instructions following a Simple Sequential Execution (SSE) model. This means that the processor behaves as if the processor fetched, decoded and executed one instruction at a time, and in the order in which the instructions appeared in memory.

In practice, modern processors have pipelines that can execute multiple instructions at once, and may do so out of order. This diagram shows an example pipeline for an Arm Cortex processor:

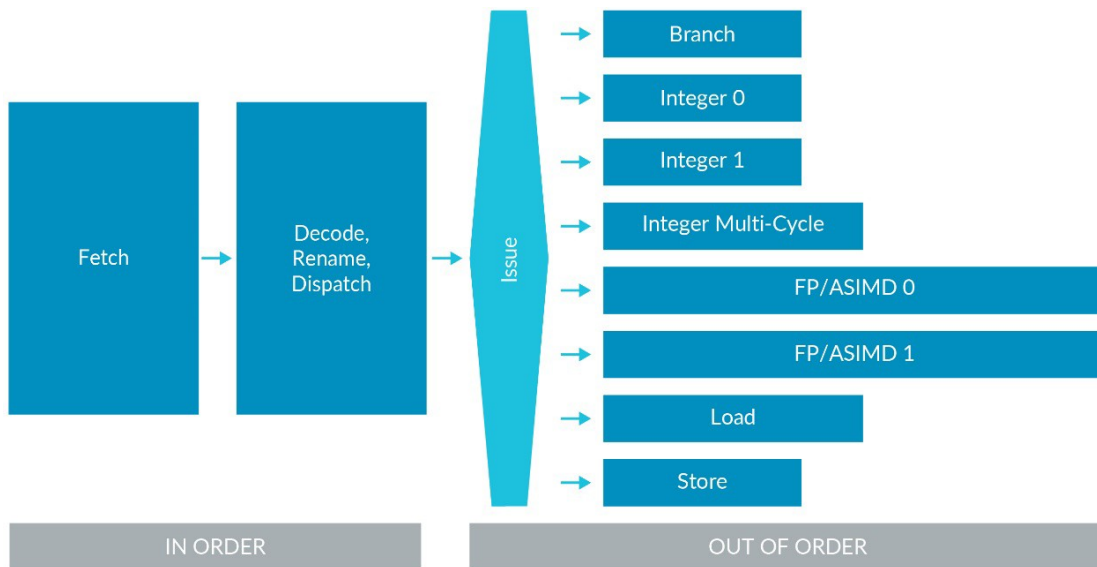

You will remember that the architecture is a functional description. This means that it does not specify how an individual processor works. Each processor must behave consistently with the simple sequential execution model, even if it is re-ordering instructions internally.

# 6 Registers in AArch64

## 6.1 General-purpose registers

Most A64 instructions operate on registers. The architecture provides 31 general purpose registers. Each register can be used as a 64-bit **x** register (**x0** . . **x30**), or as a 32-bit **w** register (**w0** . . **w30**). These are two separate ways of looking at the same register. For example, this register diagram shows that **w0** is the bottom 32 bits of **x0**, and **w1** is the bottom 32 bits of **x1**:



For data processing instructions, the choice of **x** or **w** determines the size of the operation. Using **x** registers will result in 64-bit calculations, and using **w** registers will result in 32-bit calculations. This example performs a 32-bit integer addition:

```
ADD W0, W1, W2
```

This example performs a 64-bit integer addition:

```
ADD X0, X1, X2
```

When a **w** register is written, as seen in the example above, the top 32 bits of the 64-bit register are zeroed.

There is a separate set of 32 registers used for floating point and vector operations. These registers are 128-bit, but like the general-purpose registers, can be accessed in several ways. **Bx** is 8 bits, **Hx** is 16 bits and so on to **Qx** which is 128 bits.

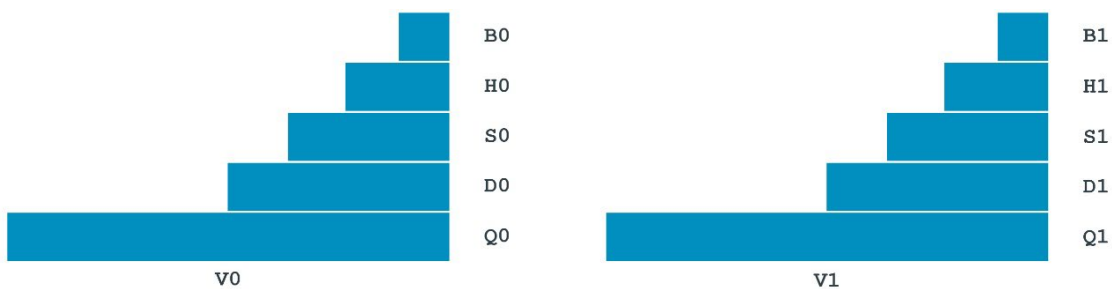

The name you use for the register determines the size of the calculation. This example performs a 32-bit floating point addition:

```
FADD S0, S1, S2
```

This example performs a 64-bit floating point addition:

```
FADD D0, D1, D2
```

These registers can also be referred to as  $v$  registers. When the V form is used, the register is treated as being a vector. This means that it is treated as though it contains multiple independent values, instead of a single value. This example performs vector floating point addition:

```
FADD V0.2D, V1.2D, V2.2D
```

This example performs vector integer addition:

```
ADD V0.2D, V1.2D, V2.2D
```

We will look at vector instructions in more detail later in this guide.

## 6.2 Other registers

Here are some other registers in the A64 that you should know about:

The zero registers, ZXR and WZR, always read as 0 and ignore writes.

You can use the stack pointer (SP) as the base address for loads and stores. You can also use the stack pointer with a limited set of data-processing instructions, but it is not a regular general purpose register.

Armv8-A has multiple stack pointers, and each one is associated with a specific Exception level. When SP is used in an instruction, it means the current stack pointer. The guide to the exception model explains how the stack pointer is selected.

X30 is used as the Link Register and can be referred to as LR.

**Note: Separate registers, ELR\_ELx, are used for returning from exceptions. This is discussed in more detail in the guide to the exception model.**

The Program Counter (PC) is not a general-purpose register in A64, and it cannot be used with data processing instructions. The PC can be read using:

```
ADR Xd, .
```

The ADR instruction returns the address of a label, calculated based on the current location. Dot ('.') means 'here', so the shown instruction is returning the address of itself. This is equivalent to reading the PC. Some branch instructions, and some load/store operations, implicitly use the value of the PC.

**Note: In the A32 and T32 instruction sets, the PC and SP are general purpose registers. This is not the case in A64 instruction set.**

## 6.3 System registers

As well as general purpose registers, the architecture defines system registers. System registers are used to configure the processor and to control systems such as the MMU and exception handling.

System registers cannot be used directly by data processing or load/store instructions. Instead, the contents of a system register need to be read into an **X** register, operated on, and then written back to the system register. There are two specialist instructions for accessing system registers:

```
MRS    Xd, <system register>
```

reads the system register into **Xd**.

```
MSR    <system register>, Xn
```

write **Xn** to the system register.

System registers are specified by name, for example **SCTLR\_EL1**:

```
MRS    X0, SCTLR_EL1
```

reads **SCTLR\_EL1** into **X0**.

System register names end with **\_ELx**. The **\_ELx** specifies the minimum privilege necessary to access the register. For example:

```
SCTLR_EL1
```

requires EL1 or higher privilege.

```
SCTLR_EL2
```

requires EL2 or higher privilege.

```
SCTLR_EL3
```

requires EL3 privilege

Attempting to access the register with insufficient privilege results in an exception.

**Note: Sometimes you will see **\_EL12** or **\_EL01**. These are used as part of virtualization. Refer to the guide on virtualization for more information.**

# 7 Data processing

## 7.1 Arithmetic and logic operations

The basic format of logical and integer arithmetic instructions is:

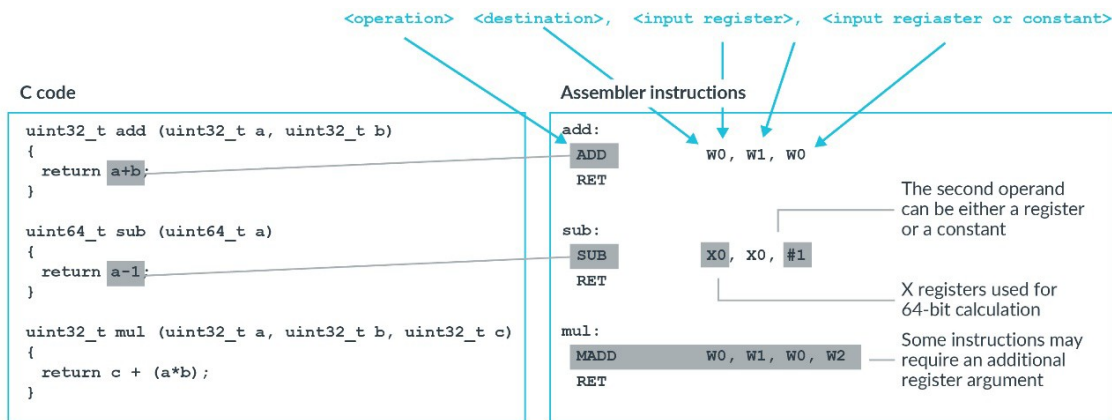

The parts of the instruction are as follows:

- Operation. This defines what the instruction does. For example, ADD does addition and AND performs a logical AND.

An S can be added to the operation to set flags. For example, ADD becomes ADDS. This s tells the processor to update the ALU flags based on the result of instruction. We discuss ALU flags in the section on generating condition code.

- Destination: The destination of the instruction is always a register, and specifies where the result of the operation is placed. Most instructions have a single destination register. A few instructions have two destination registers. When the destination is a W register, the upper 32 bits of the corresponding X register are set to 0.
- Operand 1: This will always be a register. This is the first input to the instruction.
- Operand 2: This will be a register or a constant, and is the second input to the instruction.

When operand 2 is a register, it may include an optional shift.

When operand 2 is a constant, it is encoded within the instruction itself. This means that the range of constants available is limited.

You should be aware of a couple of special cases, such as the `MOV` and `MVN` instructions. `MOV` moves a constant, or the contents of another register, into the register specified as the destination. `MOV` and `MVN` only require a single input operand, which can be either a register or a constant, as shown here:

```
MOV    X0, #1
```

sets:  $X0 = 1$

```
MVN    W0, W1
```

sets:  $W0 = \sim W1$

## 7.2 Floating point

Floating-point operations follow the same format as integer data-processing instructions and use floating-point registers. Like with the integer data-processing instructions, the size of the operation determines the size of the register that is used. The operation part of a floating-point instruction always starts with an F. For example, this instruction sets  $H0 = H1 / H2$  with half precision:

```
FDIV   H0, H1, H2
```

This instruction sets  $S0 = S1 + S2$  with single precision:

```
FADD   S0, S1, S2
```

This instruction sets  $D0 = D1 - D2$  with double precision:

```
FSUB   D0, D1, D2
```

Support for half precision (16 bit) was added in Armv8.2-A and is optional. Support for half-precision is reported by `ID_AA64PFR0_EL1`.

Access to floating point registers can be trapped. This means that any attempt to use floating point registers will generate an exception. Trapping is discussed in more detail the exception model guide.

### 7.2.1 Is floating point support optional?

No. Support for floating point is mandatory in Armv8-A. The architecture specifies that it is required whenever a rich operating system, such as Linux, is used.

You are technically permitted to omit floating point support, if you are running an entirely proprietary software stack. Most toolchains, including GCC and Arm Compiler 6, will assume floating point support.





Other instructions can reverse byte or bit order, as you can see in this figure:

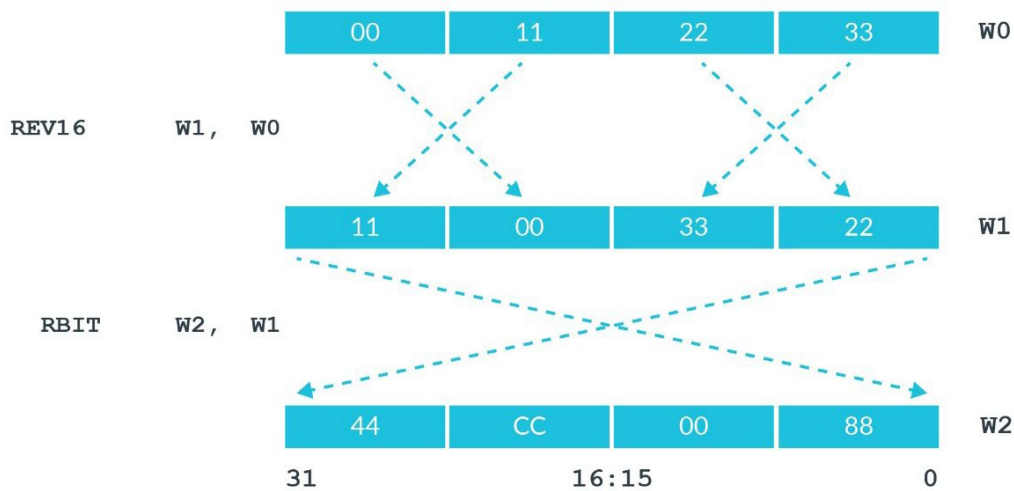

**REV16** and **RBIT** are particularly useful when you are handling data that is in a different endianness.

**Test yourself:** The **REV16** instruction reverses the two halfwords (16 bits) within a **W** register. In the preceding figure, there is an instruction to reverse the bytes in an entire register, and an instruction for byte reversing the words within an **X** register. What are these two instructions called?

Download the [instruction set XML](#) to see if you are correct.

## 7.4 Extension and saturation

Sometimes it is necessary to convert data from one size to another. The **SXTx** (sign extend) and **UXTx** (unsign extend) instructions are available for this conversion. In this conversion, the **x** determines the size of the data being extended, as shown in this figure:

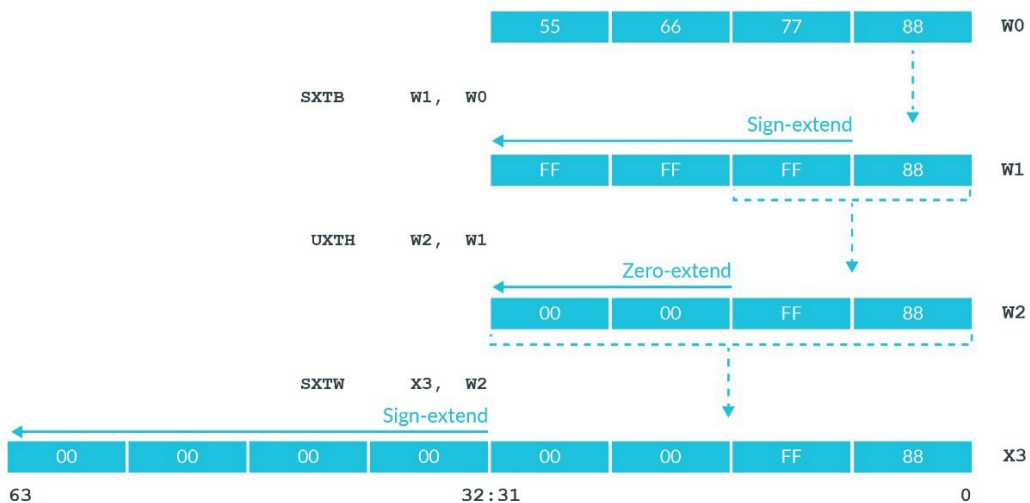

In the first instruction, `SXTB`, the B means byte. It takes the bottom byte of `w0` and sign extends it to 32 bits.

`UXTH` is an unsigned extension of a halfword (`H`). It takes the bottom 16 bits of `w1` and zero extends it to 32 bits.

The first two examples have `w` registers as a destination, meaning the extension is to 32 bits. The third example has an `x` register, meaning the sign extension is to 64 bits.

**Test yourself: Write an instruction to sign extend a byte in `W5` to 64 bits, placing the result in `X7`.**

`SXTB X7, W5`

### 7.4.1 Sub-register-sized integer data processing

Some instructions perform saturating arithmetic. This means that if the result is larger or smaller than the destination can hold, then the result is set to the largest or smallest value of the destination's integer range.

The data-processing instructions can efficiently handle 32-bit data and 64-bit data. In practice, you often see saturation instructions when handling sub-register calculations. Sub-register calculations are calculations of 16 bits or 8 bits. This table shows some examples of sub-register calculations in C and the generated assembler code:

C	Generated assembler
<pre>uint32_t add32(uint32_t a, uint32_t b) {     return a+b; }</pre>	<pre>add32:     ADD W0, W1, W0     RET</pre>
<pre>uint16_t uadd16(uint16_t a, uint16_t b) {     return a+b; }</pre>	<pre>uadd16:     AND W8, W1, #0xffff     ADD W0, W8, W0, UXTH     RET</pre>
<pre>int16_t sadd16(int16_t a, int16_t b) {     return a+b; }</pre>	<pre>sadd16:     SXTH W8, W1     ADD W0, W8, W0, SXTH     RET</pre>

In the first example in the table, the 32-bit addition maps onto `w` registers and therefore can be handled easily.

For the 16-bit examples in the table, an extra instruction is necessary. The third example in the table takes the 16-bit inputs, extends them to 32 bits, and then performs the addition. The sequence converts the 16-bit input to 32 bits, using:

```
SXTH W8, W1
```

Then, this instruction performs the addition and saturates the result to signed 16 bits:

```
ADD W0, W8, W0, SXTH
```

Adding `SXTH` to the end of the operand list of the `ADD` operation causes the result to use saturating arithmetic. Because the destination is a `W` register, the `ADD` will saturate to a 16-bit integer range.

## 7.5 Format conversion

We have seen that the `MOV` and `MVN` instructions copy the value from one register to another. Similarly, `FMOV` can be used to copy between floating-point and general purpose registers.

However, using `FMOV` copies the literal bit pattern between the registers. There are also instructions that can convert to the closest representation, as this figure shows:

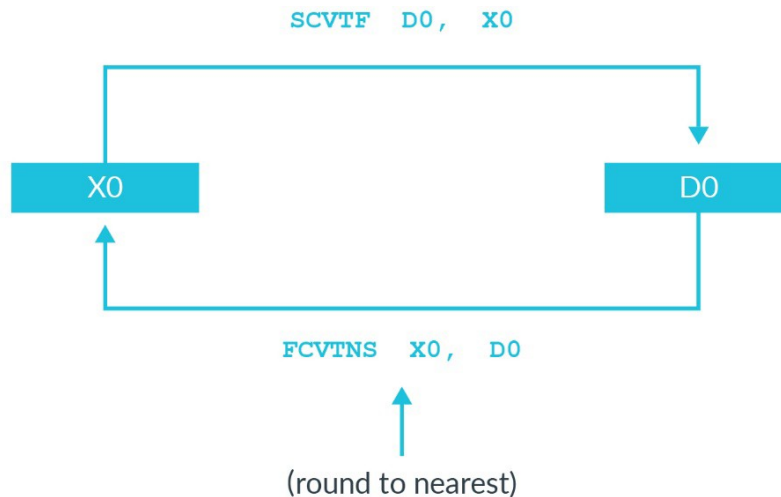

In this example, imagine that X0 contains the value 2 (positive integer 2):

```
X0 = 0x0000_0000_0000_0002
```

Then, the following sequence is executed:

```
FMOV D0, X0
```

```
SCVTF D1, X0
```

Both instructions “copy” X0 into a D register. However, the results are quite different:

```
D0 = 0x0000_0000_0000_0002 = 9.88131e-324  
D1 = 0x4000_0000_0000_0002 = 2.0
```

The `FMOV` copied the literal bit pattern, which is a very different value when interpreted as a floating-point value. The `SCVTF` converted the value in X0 to the closest equivalent in floating-point.

Similarly, `FCTXX` can be used to convert a floating-point value to its closest integer representation. In this instance, different values of 'xx' control the rounding mode used.

## 7.6 Vector data

The A64 architecture also provides support for vector data processing. The two types of vector processing available are:

- Advanced SIMD, which is also known as Neon.
- Scalable Vector Extension, which is abbreviated to SVE.

We will cover both types of vector processing in a later guide on vector programming.

**Note: The name Advanced SIMD derives from the existence of SIMD instructions that operated on regular 32-bit general-purpose registers in Armv6. In Armv7, the term Advanced SIMD was used for instructions that could operate on 128-bit vectors. The Armv6 style instructions do not exist in A64, but the naming convention remains.**

# 8 Loads and stores

The basic load and store operations are: **LDR** (load) and **STR** (store). These operations transfer a single value between memory and the general-purpose registers. The syntax for these instructions is:

```
LDR<Sign><Size>    <Destination>, [<address>]
STR<Size>          <Destination>, [<address>]
```

## 8.1 Size

The size of the load or store is determined by the register type **x** or **w** and the **<Size>** field. **x** is used for 32 bits and **w** is used for 64 bits. For example, this instruction loads 32 bits from **<address>** into **w0**:

```
LDR    w0, [<address>]
```

This instruction loads 64 bits from **<address>** into **x0**:

```
LDR    x0, [<address>]
```

The **<Size>** field allows you to load a sub-register sized quantity of data. For example, this instruction stores the bottom byte (**B**) of **w0** to **<address>**:

```
STRB   w0, [<address>]
```

This instruction stores the bottom halfword (**H**) of **w0** to **<address>**:

```
STRH   w0, [<address>]
```

Finally, this instruction stores the bottom word (**w**) of **x0** to **<address>**:

```
STRW   x0, [<address>]
```

## 8.2 Zero and sign extension

By default, when a sub-register-sized quantity of data is loaded, the rest of the register is zeroed, as shown in this figure:

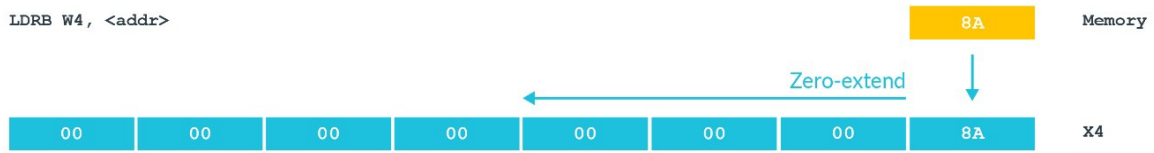

**Note:** Remember that whenever a **w** register is written, the top half of the **x** register is zeroed.

Adding an **S** to the operation causes the value to be sign extended instead. How far the size extension goes depends on whether the target is a **w** or **X** register, as shown in this figure:

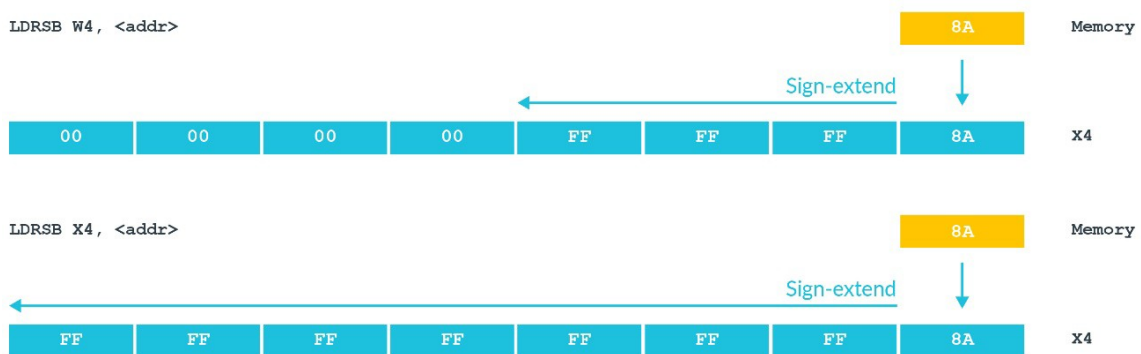

**Task:** If the byte at address `0x8000` contains the value `0x1F`, what would be the result of `LDRSB X4, <0x8000>` be?

*LDRSB is performing a byte load with sign extension to 64 bits. The most significant bit of the loaded value will be replicated to fill the 64-bit register. The loaded value, `0x1F`, has its top bit clear. Therefore, the value in `X4` will be `0x0000_0000_0000_001F`.*

## 8.3 Addressing

The addresses for load and store instructions appear within the square brackets, as shown in this example:

```
LDR W0, [X1]
```

There are several addressing modes that define how the address is formed.

- Base register - The simplest form of addressing is a single register. Base register is an X register that contains the full, or absolute, virtual address of the data being accessed, as you can see in this figure:

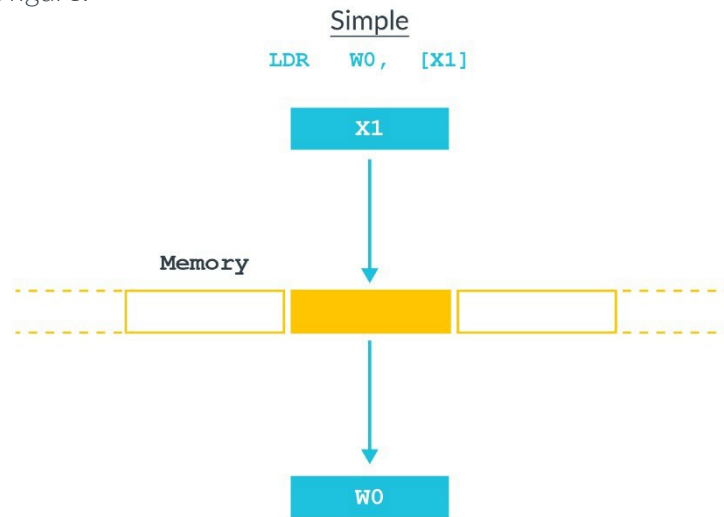

- Offset addressing modes - An offset can be applied optionally to the base address, as you can see in this figure:

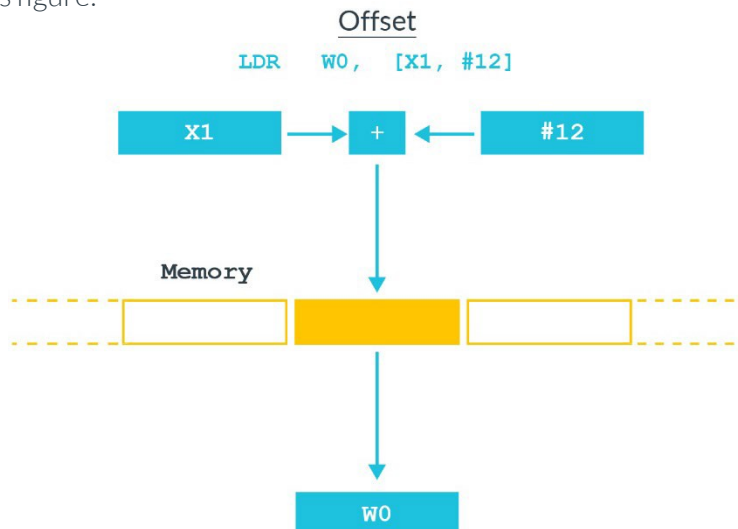

In the preceding figure, `X1` contains the base address and `#12` is a byte offset from that address. This means that the accessed address is `X1+12`. The offset can be either a constant or another register. This type of addressing might be used for structs, for example. The compiler maintains a pointer to the base of struct using the offset to select different members.



- Pre-index addressing modes - In the instruction syntax, pre-indexing is shown by adding an exclamation mark ! after the square brackets, as this figure shows:

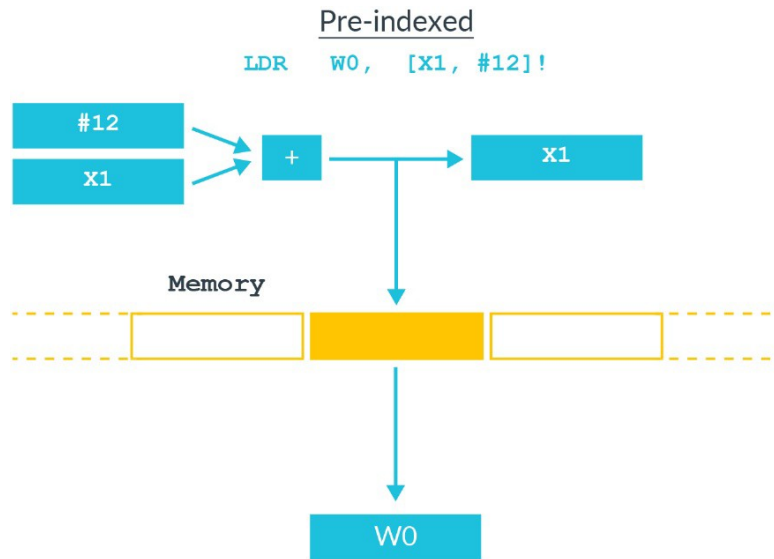

Pre-indexed addressing is like offset addressing, except that the base pointer is updated as a result of the instruction. In the preceding figure, `x1` would have the value `x1+12` after the instruction has completed.

- Post-index addressing modes - With post-index addressing, the value is loaded from the address in the base pointer, and then the pointer is updated, as this figure shows:

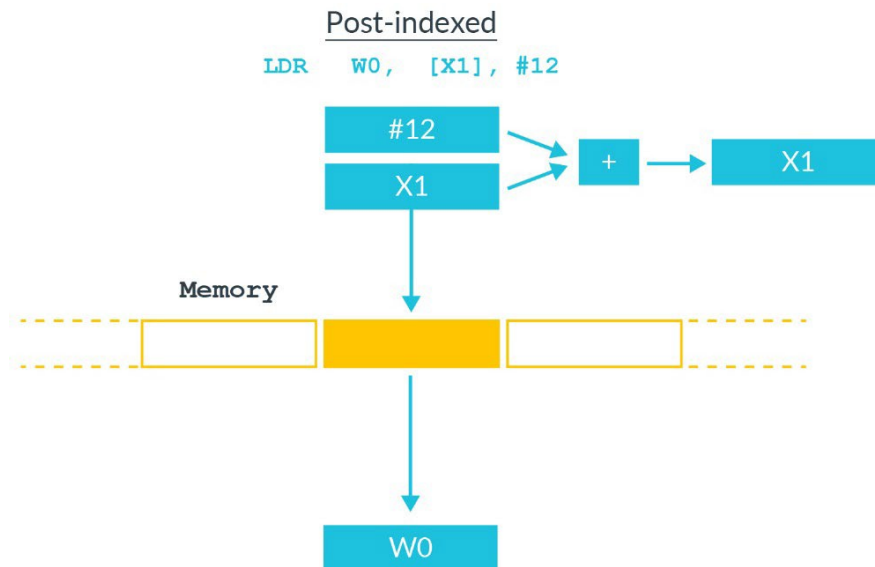

Post-index addressing is useful for popping off the stack. The instruction loads the value from the location pointed at by the stack pointer, and then moves the stack pointer on to the next full location in the stack.

## 8.4 Load pair and store pair

So far, we have discussed the load and store of a single register. A64 also has load (LDP) and store pair (STP) instructions.

These pair instructions transfer two registers to and from memory. The first instruction loads [X0] into W3, and loads [X0 + 4] into W7:

```
LDP    W3, W7, [X0]
```

This second instruction stores D0 into [X4] and stores D1 to [X4 + 8]:

```
STP    D0, D1, [X4]
```

Load and store pair instructions are often used for pushing, and popping off the stack. This first instruction pushes X0 and X1 onto the stack:

```
STP    X0, X1, [SP, #-16]!
```

This second instruction pops X0 and X1 from the stack:

```
LDP    X0, X1, [SP], #16
```

Remember that in AArch64 the stack-pointer must be 128-bit aligned.

## 8.5 Using floating point registers

Loads and stores can also be carried out using the floating-point registers, as we will see here. The first instruction loads 64-bits from [X0] into D1:

```
LDR    D1, [X0]
```

This second instruction stores 128-bits from Q0 to [X0 + X1]:

```
STR    Q0, [X0, X1]
```

Finally, this instruction loads a pair of 128-bit values from X5, then increments X5 by 256:

```
LDP    Q1, Q3, [X5], #256
```

There are some restrictions:

- The size is specified by the register type only.
- There is no option to sign extend loads.
- The address must still be an X register.

Load and stores using floating-point registers can be found in unexpected cases. It is common for `memcpy()` type routines to use them. This is because the wider register means that fewer iterations are needed. Just because your code does not use floating-point values, don't assume that you won't need to use the floating-point registers.

# 9 Program flow

Ordinarily, a processor executes instructions in program order. This means that a processor executes instructions in the same order that they are set in memory. One way to change this order is to use branch instructions. Branch instructions change the program flow and are used for loops, decisions and function calls.

The A64 instruction set also has some conditional branch instructions. These are instructions that change the way they execute, based on the results of previous instructions.

**Note: Armv8.3-A and Armv8.5-A introduced instructions to protect against return-orientated programming and jump-oriented programming.**

## 9.1 Loops and decisions

In this section, we will examine how loops and decisions let you change the flow of your program code using branch instructions. There are two types of branch instructions: unconditional and conditional.

### 9.1.2 Unconditional branch instructions

The unconditional branch instruction `B <label>` performs a direct, PC-relative, branch to `<label>`. The offset from the current PC to the destination is encoded within the instruction. The range is limited by the space available within the instruction to record the offset and is +/- 128MB.

When you use `BR <Xn>`, BR performs an indirect, or absolute, branch to the address specified in `Xn`.

### 9.1.3 Conditional branch instructions

The conditional branch instruction `B.<cond> <label>` is the conditional version of the `B` instruction. The branch is only taken if the condition `<cond>` is true. The range is limited to +/- 1MB.

The condition is tested against the ALU flags stored in `PSTATE` and needs to be generated by a previous instruction such as a compare (`CMP`).

```
CBZ <Xn> <label> and CBNZ <Xn> <label>
```

This instruction branches to `<label>` if `Xn` contains 0 (`CBZ`), and branches to label if `Xn` does not contain 0 (`CBNZ`).

```
TBZ <Xn>, #<imm>, <label> and TBNZ <Xn>, #<imm>, <label>
```

`TBX` works in a similar way to `CBZ/CBNZ`, but tests the bit specified by `<imm>`.

**Note:** The direct, or PC-relative, branches store the offset to the destination within the instruction. The conditional branches have a smaller range. This is because some bits are needed to store the condition itself, which leaves fewer bits for the offset.

Mapping these on to what you might write in C, this table shows examples of using branches for loops and decisions:

C	Typical output from a compiler
<pre>if (a == 5)   b = 5;</pre>	<pre>CMP W0, #5 B.NE skip MOV W8, #5 skip: ...</pre>
<pre>while (a != 0) {   b = b + c;   a = a - 1; }</pre>	<pre>loop: CBZ W8, skip ADD W9, W9, W10 SUB W8, W8, #1 B loop skip: ...</pre>

**Note:** The labels shown in the output would not be created by a compiler. They are included here to aid readability.

**Test yourself:** *There is no conditional indirect branch instruction in A64. How could you construct an instruction sequence that performs an absolute branch to the address in X1, if X5 contains 0?*

*There is no single correct answer, but something like this would be acceptable:*

```
CMP X5, XZR          // Compare X5 with zero
B.NE skip           // If X5!=0 branch past BR
BR X1
skip:
...
```

## 9.2 Generating condition code

In [Program flow - loops and decisions](#), we learned that the <cond> is tested against the ALU flags stored in PSTATE.

The ALU flags are set as a side effect of data-processing instructions. To recap, an `S` at the end of an operation causes the ALU flags to be updated. This is an example of an instruction in which the ALU flags are not updated:

```
ADD    X0, X1, X2
```

This is an example of an instruction in which the ALU flags are updated with the use of `S`:

```
ADDS   X0, X1, X2
```

This method allows software to control when the flags are updated or not updated. The flags can be used by subsequent condition instructions. Let's take the following code as an example:

```
SUBS   X0, X5, #1
```

```
AND    X1, X7, X9
```

```
B.EQ   label
```

The `SUBS` instruction performs a subtract and updates the ALU flags. Then the `AND` instruction performs an and operation, and does not update the ALU flags. Finally, the `B.EQ` instruction performs a conditional branch, using flags set as result of the subtract.

The flags are:

- N - Negative
- C - Carry
- V - Overflow
- Z - Zero

Let's take the Z flag as an example. If the result of the operation was zero, then the Z flag is set to 1. For example, here the Z flag will be set if X5 is 1, otherwise it will be cleared:

```
SUBS   X0, X5, #1
```

The condition codes map on to these flags and come in pairs. Let's take EQ (equal) and NE (not equal) as an example, and see how they map to the Z flag:

The EQ code checks for `Z==1`. The NE code checks for `Z==0`.

Taking the following code as an example:

```
SUBS  W0, W7, W9
W0 = W7 - W9, Z
```

```
B.EQ  label
```

In the first line, we have a subtract operation. In the second line, the flag is set if the result is zero. In the final line, there is a branch to label if  $Z==1$ .

If  $w7==w9$ , the result of the subtraction will be zero, and the Z flag would have been set. Therefore, the branch to label will be taken if  $w7$  and  $w9$  are equal.

In addition to the regular data-processing instructions, other instructions are available that only update the ALU flags:

CMP - Compare

TST - Test

These instructions are aliases of other instructions. For example:

```
CMP X0, X7      //an alias of SUBS XZR, X0, X7
TST W5, #1     //an alias of ANDS WZR, W5, #1
```

By using the Zero register as a destination, we are discarding the result of the operation and only updating the ALU flags.

**Test yourself: The examples we seen so far have used the EQ and NE conditions. Write a sequence that will set X0 to 5 if the result of (X5 - X6) is negative. To do this, you will need to look up the full list of condition codes in the Arm ARM.**

There are several sequences you could write. Here is one example:

```
SUBS  XZR, X5, X6
B.PL  1a      //Branch is positive or zero
MOV   X0, #5  //Only executed if result was negative
1:
...
```

A conditional select instruction might be a better choice here.

## 9.3 Conditional select instructions

So far, we have seen examples that use branches to handle decisions. The A64 instruction set also provides conditional select instructions. In many cases, these instructions can be used as an alternative to branches.

There are many variants, but the basic form is:

```
CSEL  Xd, Xn, Xm, cond
```

This means that:

```
if cond then
    Xd = Xn
else
    Xd = Xm
```

You can see an example in this code:

```
CMP    W1, #0
CSEL   W5, W6, W7, EQ
```

Which gives the same result as:

```
if (W1==0) then
    W5 = W6
else
    W5 = W7
```

There are variants that combine another operation with the conditional select. For example, CSINC performs a select and addition:

```
CSINC  Xd, Xn, Xm, cond
```

This means that:

```
if cond then
    Xd = Xn
else
    Xd = Xm + 1
```

To just conditionally increment, you could write:

```
CSINC X0, X0, X0, cond
```

Which equates to:

```
if cond then
    X0 = X0
else
    X0 = X0 + 1
```

The architecture provides an alias, CINC, for this command. Note however that CINC inverts the logic of CSINC:

- CSINC X0, X0, X0, cond
  - leaves X0 unchanged if cond is true
  - increments X0 if cond is false.
- CINC X0, X0, X0, cond
  - increments X0 if cond is true
  - leaves X0 unchanged if cond is false

Compilers choose the most efficient method to implement the functionality in your program. Compilers will often use a conditional select for small if ... else statements performing simple operations, because conditional selects can be more efficient than branches.

Here are some simple if ... else examples that compare implementations using branches to equivalent implementations using conditional select instructions:

C	Branching	Conditional select
<pre>if (a != 0)     b = b + 1;</pre>	<pre>CMP W0, #0     B.EQ else     ADD W1, W1, #1 else:     ...</pre>	<pre>CMP W0, #0 CINC W1, W1, NE</pre>
<pre>if (a == 0)     y = y + 1; else     y = y - 1;</pre>	<pre>CMP W0, #0     B.NE else     ADD W1, W1, #1     B end else:     SUB W1, W1, #1 end:     ...</pre>	<pre>CMP W0, #0 SUB W2, W1, #1 CSINC W1, W2, W1, NE</pre>

In these types of examples, conditional selects have some advantages. The sequences are shorter and take the same number of instructions, regardless of the outcome.

Importantly, conditional selects also remove the need to branch. In modern processors, this kind of branch can be difficult for the branch prediction logic to predict correctly. A mispredicted branch can have a negative effect on performance, it is better that you remove branches where possible.





# 11 Procedure Call Standard

The Arm architecture places few restrictions on how general purpose registers are used. To recap, integer registers and floating-point registers are general purpose registers. However, if you want your code to interact with code that is written by someone else, or with code that is produced by a compiler, then you need to agree rules for register usage. For the Arm architecture, these rules are called the Procedure Call Standard, or PCS.

The PCS specifies:

- Which registers are used to pass arguments into the function.
- Which registers are used to return a value to the function doing the calling, known as the caller.
- Which registers the function being called, which is known as the callee, can corrupt.
- Which registers the callee cannot corrupt.

Consider a function `foo()`, being called from `main()` :

```
extern uint32_t foo (uint32_t, uint32_t);           .global foo
                                                    .type foo, @function
```

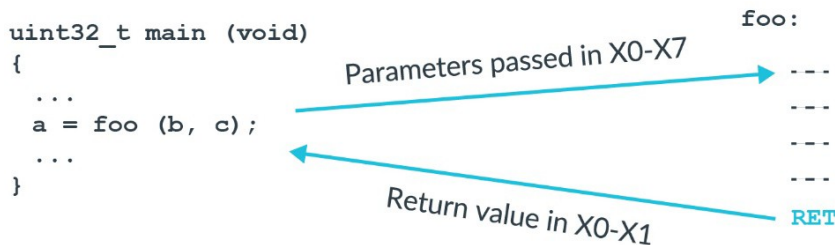

The PCS says that the first argument is passed in `x0`, the second argument in `x1`, and so on up to `x7`. Any further arguments are passed on the stack. Our function, `foo()`, takes two arguments: `b` and `c`. Therefore, `b` will be in `w0` and `c` will be in `w1`.

Why `w` and not `x`? Because the arguments are a 32-bit type, and therefore we only need a `w` register.

**Note:** In C++, `x0` is used to pass the implicit `this` pointer that points to the called function.

Next, the PCS defines which registers can be corrupted, and which registers cannot be corrupted. If a register can be corrupted, then the called function can overwrite without needing to restore, as this table of PCS register rules shows:

X0-X7	X8-X15	X16-X23	X24-X30
Parameter and Result Registers (X0-X7)	XR (X8)	IP0 (X16)	Callee-saved Registers (X24-X28)
	Corruptible Registers (X9-X15)	IP1 (X17)	
		PR (X18)	FP (X29)
	Callee-saved Registers (X19-X23)	LR (X30)	

For example, the function `foo()` can use registers X0 to X15 without needing to preserve their values. However, if `foo()` wants to use X19 to X28 it must save them to stack first, and then restore from the stack before returning.

Some registers have special significance in the PCS:

- **XR** - This is an indirect result register. If `foo()` returned a struct, then the memory for struct would be allocated by the caller, `main()` in the earlier example. XR is a pointer to the memory allocated by the caller for returning the struct.
- **IP0 and IP1** - These registers are intra-procedure-call corruptible registers. These registers can be corrupted between the time that the function is called and the time that it arrives at the first instruction in the function. These registers are used by linkers to insert veneers between the caller and callee. Veneers are small pieces of code. The most common example is for branch range extension. The branch instruction in A64 has a limited range. If the target is beyond that range, then the linker needs to generate a veneer to extend the range of the branch.
- **FP** - Frame pointer.
- **LR** - X30 is the link register (LR) for function calls.

**Note: We previously introduced the ALU flags, which are used for conditional branches and conditional selects. The PCS says that the ALU flags do not need to be preserved across a function call.**

There is a similar set of rules for the floating-point registers:

D0-D7	D8-D15	D16-D23	D24-D31
Parameter and Result Registers (D0-D7)	Callee-saved Registers (D8-D15)	Callee-saved Registers (D16-D31)	

# 12 System calls

Sometimes it is necessary for software to request a function from a more privileged entity. This might happen when, for example, an application requests that the OS opens a file.

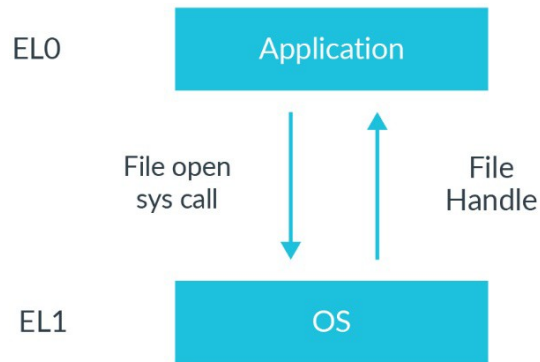

In A64, there are special instructions for making such system calls. These instructions cause an exception, which allows controlled entry into a more privileged Exception level.

- **SVC** - Supervisor call  
Causes an exception targeting EL1.  
Used by an application to call the OS.
- **HVC** - Hypervisor call  
Causes an exception targeting EL2.  
Used by an OS to call the hypervisor, not available at ELO.
- **SMC** - Secure monitor call  
Causes an exception targeting EL3.  
Used by an OS or hypervisor to call the EL3 firmware, not available at ELO.

If an exception is executed from an Exception level higher than the target exception level, then the exception is taken to the current Exception level. This means that an SVC at EL2 would cause exception entry to EL2. Similarly, an HVC at EL3 causes exception entry to EL3. This is consistent with the rule that an exception can never cause the processor to lose privilege.

# 13 Check your knowledge

**According to the PCS, for the function `uint32_t foo(uint64_t a, uint64_t b)`, which registers will be used to pass in `a` and `b`, and to return the result?**

*`a` will be passed in `x0` and `b` will be passed in `x1`. The result will be returned in `w0`.*

**What instruction does a 64-bit floating-point addition of `D0` and `D1`, then places the result in `D5`?**

`FADD D5, D0, D1`

**What does this instruction do? `LDRSH W0, [X1, #8]`**

*It loads 16-bits from the address `X1+8` and sign extends the result to 32 bits, placing the result in `w0`.*

**What instruction is most commonly used for a function return?**

`RET`

**Which register is used to store the return address when calling a function?**

*`x30`, which can also be referred to as `LR`.*

**What does executing an `SVC` instruction in an application do?**

*It would cause an exception, leading to entry into the OS.*

**After executing `SUB W5, W8, W4`, what is in the upper 32 bits of `x5`?**

*`0s` (zeroes). Whenever a `w` register is written, the upper 32 bits of the mapped `x` register are zeroed.*

# 14 Related information

Here are some resources related to material in this guide:

- [Vectors: Neon guide](#) (coming soon).
- [Vectors: SVE guide](#) (coming soon).
- [Building an embedded image guide](#) (coming soon).
- [Arm architecture and reference manuals](#) (for information on the extensions to Armv8.3-A and Armv8.5-A instruction sets, vector data-processing instructions, Advance SIMD and SVE)
- [Arm community](#) (ask development questions, and find articles and blogs on specific topics from Arm experts)
- [ARM Assembly Language by William Hohl \(ISBN: 978-1-4398-06104\)](#)
- [Building an ELF Image for an Armv8-A Fixed Virtual Platform](#) (blog post)
- [Changing Exception Level and Security State with an Armv8-A Fixed Virtual Platform](#) (blog post)
- [Cortex-A Programmer's Guide](#)
- [Retargeting and Enabling Exceptions with an ELF Image](#) (blog post)

Here are some resources related to topics in this guide:

## 14.1 Instruction set resources

- [Arm A64 instruction descriptions](#)

## 14.2 Procedure Call Standard

- [Procedure Call Standard \(PCS\) for the ARM 64-bit Architecture \(AArch64\)](#)

## 14.3 Useful links to training:

- [Introduction to Armv8-A](#)
- [Overview - ISA](#)
- [Architecture profiles](#)
- [What does architecture consist of?](#)

# 15 Next steps

Using the Arm *Instruction Set Architecture* (ISA), you can write software or firmware that any Arm-based processor will execute in the same way, if that software or firmware conforms to the Arm specifications. In this guide, we introduced the A64 instruction set, which is used in Armv8-A AArch64. We introduced the format of the instructions, the different types of instruction, and how code written in assembler can interact with compiler-generated code. We explained the main classes of instructions, the syntax of data-processing instructions, and how the use of `w` and `x` registers affects instructions.

Based on the material learned in this guide, you can explain how generated assembler code maps to C statements when given a C program and compiler output, and how to write a function in assembler that can be called from C. You will also understand how to find detailed descriptions for each instruction on the Arm Developer website, and concepts such as registers, data processing, program flow, and loads and stores.

To keep learning about the Armv8-A architecture, see more in our [series of guides](#).

To check your knowledge of A64 assembler, try the *ISA lab exercises (coming soon)*. The lab exercises require the Arm DS-5, Ultimate Edition. A 30-day evaluation version is available and can be used to complete the exercises.